



E4207 BB/PB boro



referencia	dismensiones	acabado	
E4230BB/PB	248x48	boro	5
E4230PB	248x48	pulido brillo	5

E4147 PB



referencia	dismensiones	acabado	
E4230PB	240x45	pulido brillo	5

M581/88K



referencia	entre ejes	acabado	
M581/88K F71	150	latón pulido	5
M581/88K F41	150	romo satinado	5

M581/3020



referencia	dismensiones	acabado	
M581/3020 F71	235x43	latón pulido	5
M581/3020 F41	235x43	romo satinado	5

C302



referencia	entre ejes	acabado	
C302CS	150	chromo satinado	1
C302NM	150	níquel mate	1
C302CR	150	chromo brillo	1
C302PB	150	pulido brillo	1
C302LM	150	latón mate	1
C302C	150	cuero	1
C302CI	150	cuero inglés	1

C311



referencia	entre ejes	acabado	
C311CS	200	chromo satinado	1
C311NM	200	níquel mate	1
C311CR	200	chromo brillo	1
C311PB	200	pulido brillo	1
C311LM	200	latón mate	1
C311C	200	cuero	1
C311CI	200	cuero inglés	1
C311M	200	marrón	1

801 techno



referencia	entre ejes	acabado	
801CS	200	chromo satinado	10
801NS	200	níquel mate	10
801CR	200	chromo brillo	10
801LP	200	pulido brillo	10
801LM	200	latón mate	10
801FU	200	fumé	10
801BO	200	cuero viejo	10
801MA	200	marrón	10

805 nuovo



referencia	entre ejes	acabado	
805CR	200	chromo brillo	10
805NS	200	níquel satinado	10
805CS	200	chromo satinado	10
805LP	200	pulido brillo	10
805LS	200	latón satinado	10
805FU	200	fumé	10
805BO	200	cuero viejo	10
805AQ	200	antiguo	10
805HI	200	hierro	10

817 angolo



827 log.gic



referencia	entre ejes	acabado	
817CR	200	chromo brillo	10
817NS	200	niquel satinado	10
817CS	200	chromo satinado	10
817LP	200	latón pulido	10
817LS	200	latón satinado	10

referencia	entre ejes	acabado	
827CR	200	chromo brillo	10
827NS	200	niquel satinado	10
827CS	200	chromo satinado	10
827LP	200	latón pulido	10
827LS	200	latón satinado	10

4

5040 aluminio



M5040/144 aluminio



referencia	entre ejes	acabado	
5040 F1	220	aluminio F1	5
5040 NE	220	negro	5

referencia	dimensiones	acabado	
M5040/144 F1	235x43	aluminio F1	5
M5040/144 NE	235x43	negro	5

Manillón 8

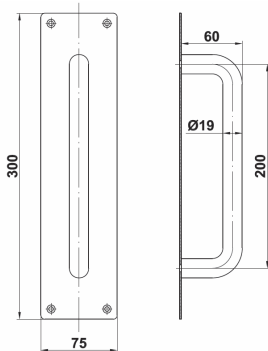

referencia	dimensiones	acabado	
12290	300x75x1.8	inoxidable	1

Manillón desplazado madera-cristal

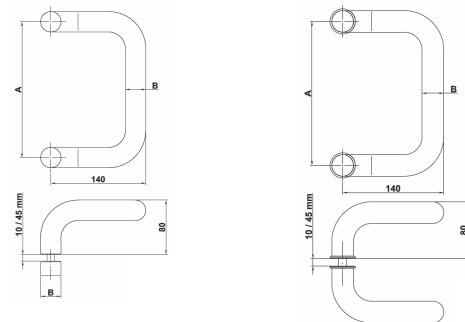

referencia	dimensiones	ud/set	acabado	
17731	Ø35x300	unitario	inoxidable	1
17733	Ø35x300	juego	inoxidable	1

Manillón 10

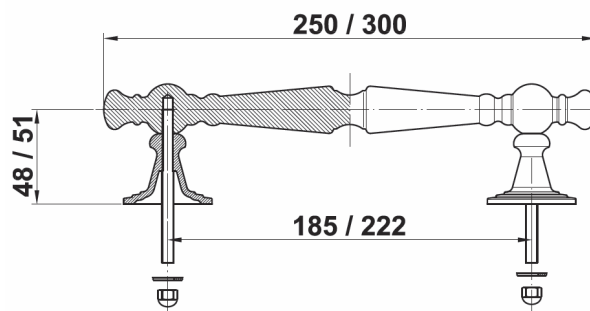

referencia	dimensiones	acabado	
5840	250	latón pulido	2
6408	250	chromo mate	2
6406	250	cuero	2
5841	300	latón pulido	2
6409	300	chromo mate	2
6407	300	cuero	2

Tirador i-1310

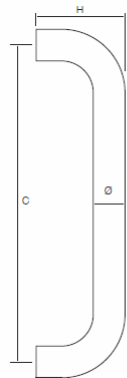

referencia	Ø	C	H	ext/set	acabado	
51020	20	200	55	ext	inoxidable	1
51120	20	200	55	int	inoxidable	1
42120	20	200	55	set	inoxidable	1
51025	20	250	55	ext	inoxidable	1
51125	20	250	55	int	inoxidable	1
42125	20	250	55	set	inoxidable	1
51030	20	300	55	ext	inoxidable	1
51130	20	300	55	int	inoxidable	1
42130	20	300	55	set	inoxidable	1
51435	30	350	90	ext	inoxidable	1
51535	30	350	90	int	inoxidable	1
42335	30	350	90	set	inoxidable	1
51445	30	450	90	ext	inoxidable	1
51545	30	450	90	int	inoxidable	1
42345	30	450	90	set	inoxidable	1
51460	30	600	90	ext	inoxidable	1
51560	30	600	90	int	inoxidable	1
42360	30	600	90	set	inoxidable	1

Tirador big i-1000

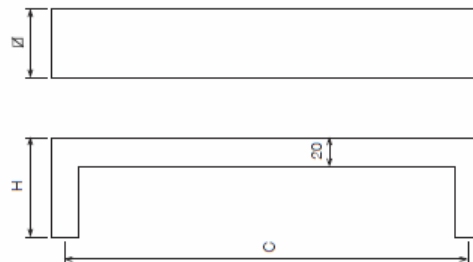

referencia	Ø	C	H	ext/set	acabado	
57420	40	200	65	ext	inoxidable	1
57520	40	200	65	int	inoxidable	1
44520	40	200	65	set	inoxidable	1
57430	40	300	65	ext	inoxidable	1
57530	40	300	65	int	inoxidable	1
44530	40	300	65	set	inoxidable	1
57450	40	500	65	ext	inoxidable	1
57550	40	500	65	int	inoxidable	1
44550	40	500	65	set	inoxidable	1



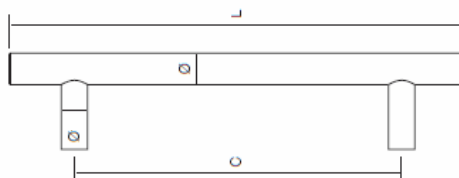

Tirador I-2000

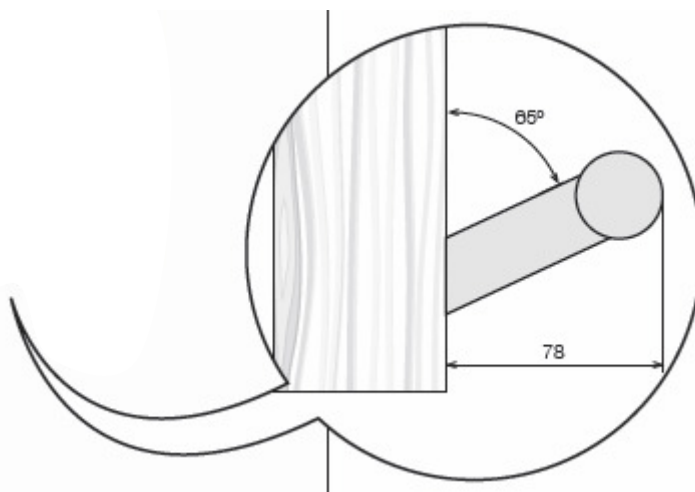
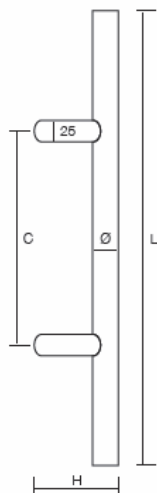

referencia	Ø	C	H	ext/set	acabado	
54020	20	200	300	ext	inoxidable	1
54120	20	200	300	int	inoxidable	1
43020	20	200	300	set	inoxidable	1
54030	20	300	450	ext	inoxidable	1
54130	20	300	450	int	inoxidable	1
43030	20	300	450	set	inoxidable	1
6104.L2.20	30	200	400	set	inoxidable	1
6104.L3.20	30	400	600	set	inoxidable	1
6104.L4.20	30	600	1000	set	inoxidable	1

Tirador I-2700



referencia	Ø	C	L	ext/set	acabado	
54425	30	250	550	ext	inoxidable	1
54525	30	250	550	int	inoxidable	1
43325	30	250	550	set	inoxidable	1

Tirador kube i-4400



KUBE

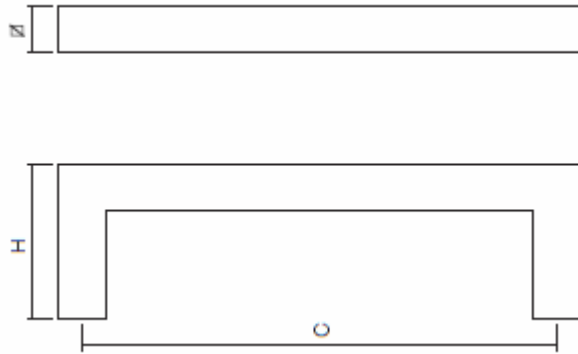

referencia	Ø	C	H	ext/set	acabado	
58220	20	200	65	ext	inoxidable	1
58320	20	200	65	int	inoxidable	1
44120	20	200	65	set	inoxidable	1
7006.70	25	250	70	set	inoxidable	1
7006.71	25	400	70	set	inoxidable	1
7006.72	25	600	70	set	inoxidable	1
7006.73	25	1000	70	set	inoxidable	1
7006.74	25	1200	70	set	inoxidable	1

4

Tirador kube i-4000



KUBE

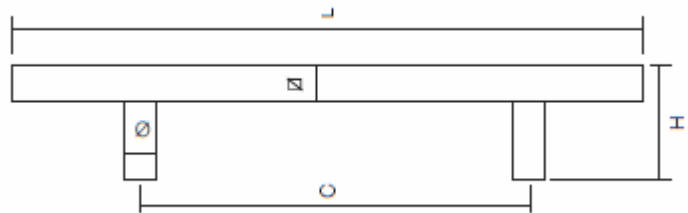

referencia	Ø	C	L	ext/set	acabado	
57020	20	200	300	ext	inoxidable	1
57120	20	200	300	int	inoxidable	1
44320	20	200	300	set	inoxidable	1
57030	20	300	450	ext	inoxidable	1
57130	20	300	450	int	inoxidable	1
44330	20	300	450	set	inoxidable	1
57250	30	500	800	ext	inoxidable	1
57350	30	500	800	int	inoxidable	1
44450	30	500	800	set	inoxidable	1
57260	30	600	900	ext	inoxidable	1
57360	30	600	900	int	inoxidable	1
44460	30	600	900	set	inoxidable	1

TCBM-38VL

TCBM-38CL

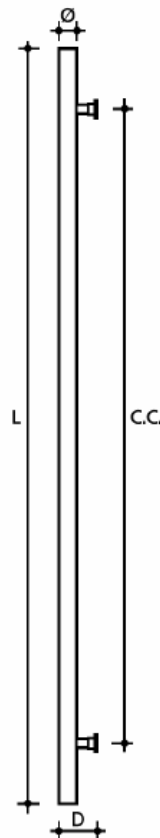
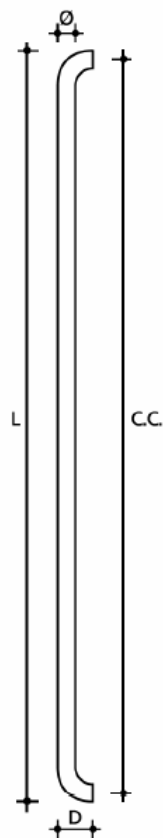



Notas:

Acabados brillo/mate a elegir.
 Válido para vidrio y madera (especificar grosor).
 Se puede pedir una unidad suelta o el juego completo (indicar grosor de puerta para el suministro de los accesorios correctos).
 En AISI316 para exterior y entornos adversos.
 Otras longitudes bajo pedido.

Notas:

Acabados brillo/mate a elegir.
 Válido para vidrio y madera (especificar grosor).
 Se puede pedir una unidad suelta o el juego completo (indicar grosor de puerta para el suministro de los accesorios correctos).
 En AISI316 para exterior y entornos adversos.
 Otras longitudes bajo pedido.

referencia	Øxccc	acabado	
TCBM-389VL	Ø38x2000	inox AISI316	1

referencia	ØxcccL	acabado	
TCBM-389VL	Ø38x1800x2000	inox AISI316	1