

**Burlete de cepillo**



referencias de pedido:

referencia	Longitud (mm)	acabado	
2-1000OR	1000	oro	10
2-1000PL	1000	plata	10
2-1000NE	1000	negro	10
2-1000BL	1000	blanco	10
2-1000BR	1000	bronce	10
2-1000RB	1000	roble	10
2-1000SP	1000	sapelly	10

**Burlete de goma automática**



Dispone de adhesivo, pero, también se puede tirafondear. Recortable desde 1.000 a 820mm y desde 820 a 720mm.

referencias de pedido:

referencia	Longitud (mm)	acabado	
3-820OR	1000	oro	4
3-820PL	1000	plata	4
3-820NE	1000	negro	4
3-820BL	1000	blanco	4
3-820BR	1000	bronce	4
3-820RB	1000	roble	4
3-1000OR	1000	oro	4
3-1000PL	1000	plata	4
3-1000NE	1000	negro	4
3-1000BL	1000	blanco	4
3-1000BR	1000	bronce	4
3-1000RB	1000	roble	4
3-1000SP	1000	sapelly	4

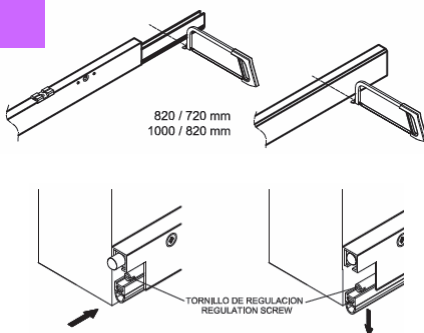

**Burlete embutido**



Recortable desde 1.200 hasta 1.000, desde 1.000 hasta 820mm y desde 820mm hasta 620mm.

referencias de pedido:

referencia	Longitud (mm)	acabado	
50482	820	aluminio	4
504100	1000	aluminio	4
504120	1200	aluminio	4

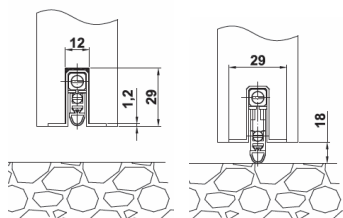

### Burlete para puerta de entrada

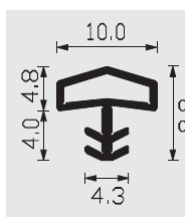

4 TIPOS DE MONTRAJE

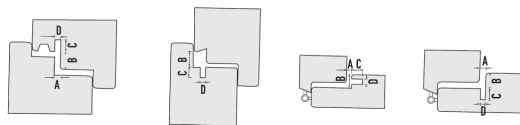

referencias de pedido:

referencia	A	B	C	D	acabado	
10693	3	10	7	3.5	avellana	10
10682	3	10	7	3.5	marrón	10
10681	3	10	7	3.5	blanco	10